

WÜRTH WOOD GROUP PRO HINGES AND PLATES

PRO
VALUE SERIES



WHY BUY PRO? | **PRO**
VALUE SERIES

QUALITY.

AFFORDABLE.

IN-STOCK.



PRO PRODUCT QUALITY

Our PRO VALUE Series has been tested in the same facilities and held to the same standards as the larger **BRAND NAMES** in the industry.



PRO PRODUCT AFFORDABILITY

Our PRO VALUE Series carries the lowest cost in the industry. We pride ourselves in being able to offer our customers **BRAND NAME** quality at import prices.



PRO PRODUCT AVAILABILITY

Our PRO VALUE Series is ALWAYS stocked in either your local branch or our HUB. We guarantee, if the product is **IN-STOCK** we will have your PRO product to you within 2 business days.



WHY PRO HINGES AND PLATES?



ONE PLATE FOR SELF & SOFT CLOSE APPLICATIONS

Our PRO VALUE hinge plates work with both PRO soft close and PRO self close hinges. This reduces overstocked inventory and allows for versatile applications of a single item.

SAME FACTORY EVERY TIME

Our PRO VALUE hinges and plates are shipped from the same factory for each order placed. This guarantees consistent quality and standards for all products ordered. Reducing variations in product quality, usability, and effectiveness.

CONCEALED, IN HINGE, OIL PISTON

Our PRO VALUE soft close hinges contain a concealed piston in the hinge arm. This unique hinge construction allows for a more consistent and smoother close.

LIMITED LIFETIME WARRANTY



Our PRO VALUE hinges and plates are backed by a lifetime limited warranty. We will replace any defective or broken hinge and plate.

BIFMA TESTED AND RATED

Our PRO VALUE hinges have been tested to meet and exceed BIFMA standards for cycle, lift, static load and self-closing performance.



PRO C80 110° PRESS-IN HINGE |



- 110° opening angle
- 8mm dowels
- All metal hinge, nickel-plated
- Box quantity: 200



SELF CLOSE

overlay	item no.
inset	PROC80C675N

SOFT CLOSE

overlay	item no.
inset	PROC80C675NF

OTHER PRO PRODUCTS AVAILABLE:

Cleaners, Adhesives, Sanders, Fill and Finish, Hinges, Hinge Plates, Slides, Lubricants, EURO Box, Lighting, and MORE!

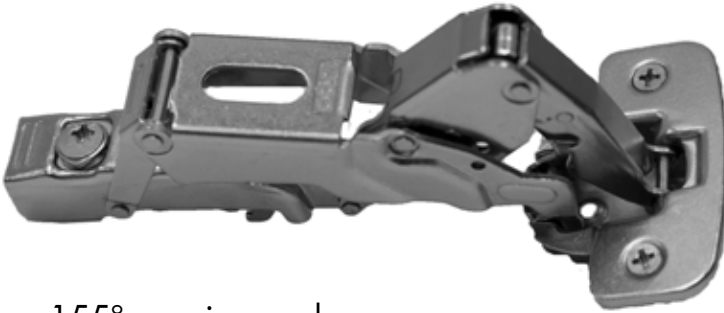

PRO C80 155° PRESS-IN HINGE | **PRO**
VALUE SERIES

- 155° opening angle
- 8mm dowel
- All metal hinge, nickel-plated
- Box quantity: 100

**SELF CLOSE**

overlay	item no.
full	PROC80A605N

SOFT CLOSE

overlay	item no.
full	PROC80A605NF

OTHER PRO PRODUCTS AVAILABLE:

Cleaners, Adhesives, Sanders, Fill and Finish, Hinges, Hinge Plates, Slides, Lubricants, EURO Box, Lighting, and MORE!



PRO C80 125° PRESS-IN HINGE |



- 125° opening angle
- 8mm dowel
- All metal hinge, nickel-plated
- Box quantity: 200



SELF CLOSE

overlay	item no.
full	PROC80A685N
half	PROC80B685N

SOFT CLOSE

overlay	item no.
full	PROC80A685NF
half	PROC80B685NF

OTHER PRO PRODUCTS AVAILABLE:

Cleaners, Adhesives, Sanders, Fill and Finish, Hinges, Hinge Plates, Slides, Lubricants, EURO Box, Lighting, and MORE!



PRO C85 +90° ANGLED PRESS-IN HINGE**PRO**
VALUE SERIES

- +90°
- Cam Adjust
- 8mm dowel
- All metal hinge, nickel-plated
- Box quantity: 200

**SELF CLOSE**

opening	item no.
100°	PROC85J6A5N

OTHER PRO PRODUCTS AVAILABLE:

Cleaners, Adhesives, Sanders, Fill and Finish, Hinges, Hinge Plates, Slides, Lubricants, EURO Box, Lighting, and MORE!



PRO C85 +30° ANGLED PRESS-IN HINGE



- +30°
- Cam Adjust
- 8mm dowel
- All metal hinge, nickel-plated
- Box quantity: 200



SELF CLOSE

opening	item no.
95°	PROC85W615N

OTHER PRO PRODUCTS AVAILABLE:

Cleaners, Adhesives, Sanders, Fill and Finish, Hinges, Hinge Plates, Slides, Lubricants, EURO Box, Lighting, and MORE!



PRO C85 +45° ANGLED PRESS-IN HINGE

- +45°
- Cam Adjust
- 8mm dowel
- All metal hinge, nickel-plated
- Box quantity: 200

**SELF CLOSE**

opening	item no.
95°	PROC85E615N

OTHER PRO PRODUCTS AVAILABLE:

Cleaners, Adhesives, Sanders, Fill and Finish, Hinges, Hinge Plates, Slides, Lubricants, EURO Box, Lighting, and MORE!



PRO COMPACT FACE FRAME PRESS-IN HINGE

PRO
VALUE SERIES



- 3-way cam adjustable
- One piece assembly
- Wrap around mount
- Opening angle: 105°
- Depth of hinge cup: 10.5mm
- Diameter of hinge cup: 35mm
- Drilling distance: 2.5mm
- Box quantity: 300

SELF CLOSE

overlay	item no.
1/2"	PRORED123
1 1/4"	PRORED1143

OTHER PRO PRODUCTS AVAILABLE:

Cleaners, Adhesives, Sanders, Fill and Finish, Hinges, Hinge Plates, Slides, Lubricants, EURO Box, Lighting, and MORE!



PRO HINGE PLATE**PRO**
VALUE SERIES

- Works with all PRO hinges
- All metal plate, nickel-plated
- Stamp Steel
- Box quantity: 400

thickness	item no.
0mm	PRO96H00AQ
2mm	PRO96H20AQ
4mm	PRO96H40AQ

OTHER PRO PRODUCTS AVAILABLE:

Cleaners, Adhesives, Sanders, Fill and Finish, Hinges, Hinge Plates, Slides, Lubricants, EURO Box, Lighting, and MORE!



PRO HINGE PLATE W/ EURO SCREW

PRO
VALUE SERIES



- Works with all PRO hinges
- Euro Screws
- Stamp Steel
- Box quantity: 400

thickness	item no.
0mm	PRO96H02AQ
2mm	PRO96H22AQ
4mm	PRO96H42AQ

OTHER PRO PRODUCTS AVAILABLE:

Cleaners, Adhesives, Sanders, Fill and Finish, Hinges, Hinge Plates, Slides, Lubricants, EURO Box, Lighting, and MORE!

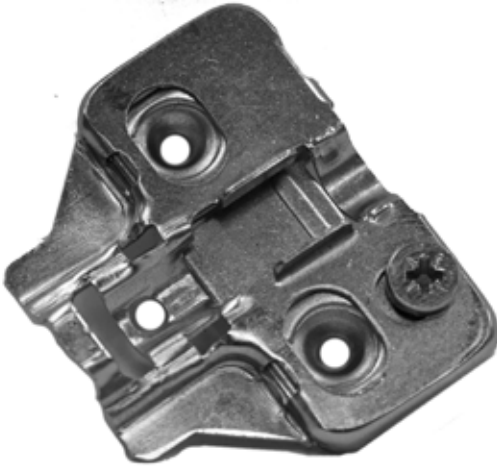

PRO HINGE PLATE W/ CAM ADJUST**PRO**
VALUE SERIES

- Works with all PRO hinges
- All metal plate, nickel-plated
- Stamp Steel
- Box quantity: 400

thickness	item no.
0mm	PRO96T00TQ
2mm	PRO96T20TQ
4mm	PRO96T40TQ

OTHER PRO PRODUCTS AVAILABLE:

Cleaners, Adhesives, Sanders, Fill and Finish, Hinges, Hinge Plates, Slides, Lubricants, EURO Box, Lighting, and MORE!



PRO HINGE PLATE FOR CAM HINGE W/ EURO SCREW



- Works with all PRO hinges
- Euro Screws
- Stamp Steel
- Box quantity: 400

thickness	item no.
0mm	PRO96T02TQ
2mm	PRO96T22TQ
4mm	PRO96T42TQ

OTHER PRO PRODUCTS AVAILABLE:

Cleaners, Adhesives, Sanders, Fill and Finish, Hinges, Hinge Plates, Slides, Lubricants, EURO Box, Lighting, and MORE!

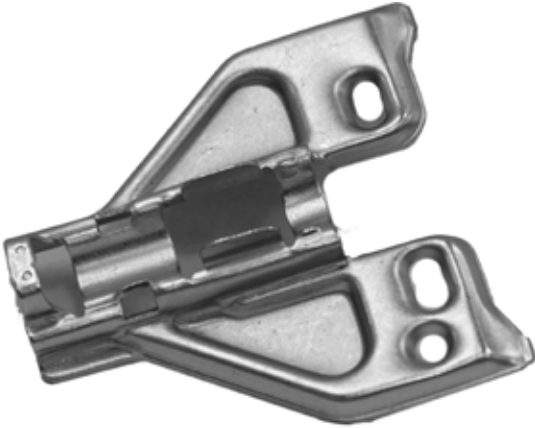

PRO HINGE PLATE FOR FACE FRAME CAM HINGE

- Works with all PRO hinges
- All metal plate, nickel-plated
- Stamp Steel
- Box quantity: 400

thickness	item no.
1mm	PRO96H10JQ
3mm	PRO96H30JQ

OTHER PRO PRODUCTS AVAILABLE:

Cleaners, Adhesives, Sanders, Fill and Finish, Hinges, Hinge Plates, Slides, Lubricants, EURO Box, Lighting, and MORE!



PRO HINGE AND PLATE



PRO C80 110°



PRO C80 155°



PRO C80 125°



COMPATIBILITY CHART

















PRO C85 +90°



PRO C85 +30°



PRO C85 +45°

ALSO AVAILABLE FROM

PRO SLIDES



PRO 50



PRO 100



PRO 200



PRO 500

PRO CLEANERS



COUNTERS



MARBLE
GRANITE



STAINLESS



GLASS
PLASTIC



ADHESIVE
REMOVER

PRO LUBRICANTS ADHESIVES



4 IN 1



LAMINATE
LUBRICANT



DRY
LUBRICANT



CONTACT
ADHESIVE

THE PRO VALUE SERIES



**PRO TAPE
300**



**ECONOMY
PUCK LIGHTS**



**HD PUCK
LIGHTS**



**FLEX STRIP
LIGHTS**



**TASK
STRIP LIGHTS**



**AMBIENT
STRIP LIGHTS**

PRO LIGHTING



**PRO
EURO BOX**



ATLANTA GA

5075 N. Buford Hwy Ste 100
Peachtree Corners, GA 30071
678.924.0386
888.924.0386
FAX 678.924.0391

CHATTANOOGA TN

234 Direct Connection Drive
Rossville, GA 30741
706.891.2000
800.506.9663
FAX 706.891.4229

RALEIGH NC

4213 Poole Road
Raleigh, NC 27610
919.231.6620
800.982.0999
FAX 919.231.9687

BALTIMORE MD

6660 Santa Barbara Road
Elkridge, MD 21075
410.796.7600
800.935.6229
FAX 410.796.7729

GREENSBORO NC

201 S. Pendleton Street
High Point, NC 27260
336.431.2712
800.662.9060
FAX 336.431.2750

RICHMOND VA

1701 Rhoadmiller Street
Richmond, VA 23220
804.359.1374
800.552.4046
FAX 804.353.3206

CHARLESTON SC

4325 Lear Avenue
N. Charleston, SC 29418
843.529.0808
800.466.8499
FAX 843.529.0805

GREENVILLE SC

1441 Hwy 101 South
Greer, SC 29652
864.877.7328
800.868.9669
FAX 864.877.7413

ROANOKE VA

3443 Aerial Way Drive
Roanoke, VA 24018
855.300.4455
800.948.7156
FAX 540.344.2306

CHARLOTTE NC

4250 Golf Acres Drive
Charlotte, NC 28208
704.394.9479
800.868.0291
FAX 704.398.2162

NORFOLK VA

3307 Chesapeake Blvd
Norfolk, VA 23513
757.855.3908
800.277.425
FAX 757.857.6133

TAMPA FL

5102 W. Hanna Ave. Unit B
Tampa, FL 33634
813.887.3365
800.432.1149
FAX 813.887.1902